

HE 5411

Differential pressure transducer with limit signal



Operating Instructions

(Translation of Original German version)

Imprint

HESCH Industrie-Elektronik GmbH
Boschstraße 8
31535 NEUSTADT
GERMANY
Phone: +49 5032 9535-0
Fax: +49 5032 9535-99
Internet: www.hesch.de
Email: info@hesch.de

Hanover District Court
Commercial Register 111184
VAT.-Id. No. DE813919106

General Management
Walter Schröder, Werner Brandis
Editor:
HESCH Industrie-Elektronik GmbH, Documentation Department

Copyrights



© Copyright 2020 HESCH Industrie-Elektronik GmbH. All rights reserved. The content including pictures and the design of these operating instructions are subject to copyright protection and other laws for the protection of intellectual property. The operating instructions may only be distributed as a complete document and only with reference to the source. The modification of the contents of this operating instructions is prohibited. In addition, this content may not be copied, distributed, modified or made available to third parties for commercial purposes.

Document history

Date / Version	Description / Author
16.09.2019 / 1.0	First version / Bg
25.09.2019 / 1.1	Chapter 3: Basic accuracy and temperature drift removed for analogue output; Chapter 8.1: Adaptation of heading; Chapter 8.3: Steps 9 and 10 supplemented; Chapter 9: Note removed / Bg
15.01.2020 / 1.2	Chapter 3: free from silicone, cable diameter and mean times (MTBF, MTTF) added Chapter 11: new article number for USB/TTL adapter added / Bg
03.04.2020 / 1.3	Chapter 3: technical data for relay contact added / Bg
14.04.2020 / 1.4	Chapter 3: technical data for relay contact adapted and service interface added / Bg
12.05.2020 / 1.5	All 24 VDC devices can now be used in EX zone 2 as well, except for the devices with a measuring range of ± 1.25 mbar (Sensirion sensor). Chapter 6.1 Electrical connections, Relay output (limit value): graphical explanation Chapter 8.5 Setting the measuring range: "mbar" changed to "pressure".
21.10.2020 / 1.6	Chapter 9.1 Parameter table: Damping and creep flow suppression added after software modification Chapter 10 Error messages: Error E.CAL, E. Sen. and E.Par added after software modifications
08.12.2020 / 1.7	Chapter 3 Technical data: sensor with ± 350 mbar measuring range added / Bg

TABLE OF CONTENTS

1	LEGAL PROVISIONS	5
2	SAFETY INFORMATION	6
2.1	SYMBOLS AND BASIC SAFETY INSTRUCTIONS	6
2.2	SIGNAL WORDS	6
2.3	SAFETY IN THE INDIVIDUAL OPERATING PHASES	7
2.4	DEVICE IDENTIFICATION	8
3	TECHNICAL DATA	10
4	MOUNTING	13
4.1	DIMENSIONS	13
4.2	OPENING THE DEVICE	14
4.3	MOUNTING THE DEVICE	14
5	DEVICE DESCRIPTION	15
5.1	SUMMARY OF DEVICE VERSIONS	15
5.1.1	HE 5411 Lite (without limit signal)	15
5.1.2	HE 5411 Basic (without limit signal)	15
5.1.3	HE 5411 Premium (with limit signal)	15
6	ELECTRICAL COMMISSIONING	16
6.1	ELECTRICAL CONNECTIONS	17
6.2	ASSEMBLY OF MEASURING HOSE ONTO PRESSURE CONNECTION	18
7	DISPLAY AND OPERATING ELEMENTS	19
7.1	LIMIT LED	21
7.1.1	“Limit threshold” mode	21
7.1.2	“Limit window” mode	22
8	OPERATION	23
8.1	OFFSET FOR ZEROING	23
8.2	OFFSET FOR ZEROING WITH DEVICE KEYPAD (HE 5411 PREMIUM)	24
8.3	LIMIT VALUE PARAMETER SETTING WITH DEVICE KEYPAD (HE 5411 PREMIUM)	25
8.4	ANALOGUE OUTPUT SETTING	26
8.5	SETTING THE MEASURING RANGE	26
8.6	TEST MODE	27
9	PARAMETER SETTING WITH SERVICE PC	28
9.1	PARAMETER TABLE	29
10	ERROR MESSAGES	36
11	ACCESSORIES	37
12	MAINTENANCE AND SERVICE	39

1 Legal Provisions

Manufacturer

HESCH Industrie-Elektronik GmbH, Boschstraße 8, 31535 NEUSTADT, GERMANY

Intended use

- The HE 5411 differential pressure transducer is a universal pressure transducer, mainly used in dedusting technology. It can also be used in the measurement of overpressure in clean rooms.
- The device can be operated within the operating and environmental conditions approved in these operating instructions without impairing its safety.
- The manufacturer is not liable for improper use and any resulting personal injury or material damage; the risk is borne solely by the user. Failure to comply with the above criteria for intended use will result in the expiry of the warranty and liability for the device.

Personnel qualification

All work on the differential pressure transducer may only be carried out by qualified electricians with sufficient knowledge in the field of electrical engineering.

Device Safety

The device has been constructed and tested in accordance with VDE 0411 / EN 61010-1 and has left the factory in perfect safety condition. To maintain this condition and ensure safe operation, the user must observe the notes and warnings described in this manual.

Declaration of conformity

The valid declaration of conformity can be found on the internet on www.hesch.de.

2 Safety Information

2.1 Symbols and Basic Safety Instructions

This chapter contains important safety regulations and notes. To protect against personal injury and material damage, it is necessary to read this chapter carefully before working with the device.

Symbols used

The following symbols are used in this manual. All safety instructions have a uniform structure.



Personal Injury Warning!

The severity of the danger is indicated by the respective signal word.



Explosive region warning sign!



High Voltage Warning!



Warning of material damage caused by electrostatic charge!



Property Damage Warning!



Note!

Identifies possible malfunctions and indicates optimum operating conditions.

2.2 Signal Words

DANGER!

Indicates an imminently hazardous *high* risk situation, which, if not avoided, will result in death or serious injury.

WARNING!

Indicates a potentially hazardous *medium* risk situation, which, if not avoided, could result in death or serious injury.

CAUTION!

Indicates a hazardous *low* risk situation, which, if not avoided, could result in minor or moderate injury.

2.3 Safety in the individual operating phases

When installing the device and during operation, the following safety instructions must be observed.



Danger of Electrocution!

Before working on the device, switch off all power supplies used. The electrical cables must be laid according to the respective national regulations (in Germany VDE 0100). The measuring lines must be laid separately from the mains leads.



Attention!

The device must never be put into operation even if damage is recognisable.



Warning!

Ensure protection against short circuiting in the supply circuit.



Attention!

During installation, commissioning, maintenance and troubleshooting, observe the accident prevention regulations applicable to your system, e.g. DGVV Regulation 3 "Electrical installations and equipment".



Attention!

Clean dirty contacts with oil-free compressed air or with spirit and a lint-free cloth.



Warning of material damage caused by electrostatic charge!

Observe the safety measures according to BS EN 61340-51/-3 to avoid electrostatic discharge!



Power Connection!

The electrical cables must be laid according to the respective national regulations (in Germany VDE 0100). The measuring lines must be laid separately from the mains leads.



Explosion Prevention!

HE 5411 Lite, Basic and Premium with a supply voltage of 19...36 V DC are suitable for use in explosion zones 2 and 22, provided that the lid is closed.

HE 5411 Lite, Basic and Premium with a supply voltage of 100...240 V AC are only suitable for use in explosion zone 22, provided that the lid is closed.

Devices with a measuring range of ± 1.25 mbar (regardless of the device version) do not have an ATEX certification and must not be used in potentially explosive areas.





Before opening the device, e.g. for parameter setting, it is essential to ensure that no explosive environmental conditions, such as formation of dust, exist.

2.4 Device Identification



Note!

The HE 5411 differential pressure transducer is available in three different designs. The corresponding device identification can be seen on the nameplate. Devices with a measuring range of ± 1.25 mbar (regardless of the device version) do **not** have any ATEX certification!

HE 5411 Lite	HE 5411 Basic	HE 5411 Premium
		
<p><u>The devices with 19...36 V DC are marked with:</u></p> <p>II3D Ex tc IIIC T135°C Dc IP65 </p> <p>II3G Ex nR IIC T4 Gc</p> <p><u>The devices with 100...240 V AC are marked with:</u></p> <p>II3D Ex tc IIIC T135°C Dc IP65 </p> <p><u>The devices with a measuring range of ± 1.25 mbar are marked with:</u></p> <p>CE</p>		

II3D Ex tc IIIC T135°C Dc IP65

II3D	Device category:	Use in Zone 22 for dust during normal operation
Ex	Denotes electrical equipment. Standards of the EN 60079-Off. series have been applied.	
tc	Type of ignition protection:	Protection by housing
IIIC	Explosion group:	conductive dusts
T135°C	Temperature class:	maximum permissible surface temperature
Dc	Device protection level:	Use in Zone 22 for dust
IP65	Protection type:	dust-tight and protected against water jets

Ex II3G Ex nR IIC T4 Gc

II3G	Device category/ Ex. Atmosphere:	Use in Zone 2 for gas during normal operation
Ex	denotes electrical equipment. Standards of the EN 60079-Off. series have been applied.	
nR	Type of ignition protection:	Protection by restricted breathing housing
IIC	Explosion group:	Certified for gases with an ignition power of <math><60\mu\text{J}</math> (e.g. hydrogen)
T4	Temperature class:	maximum permissible surface temperature (135°C)
Gc	Device protection level:	Use in zone 2 for gas
IP65	Protection type:	dust-tight and protected against water jets

**Troubleshooting!**

At the beginning of troubleshooting, all possible sources of faults on additional devices or supply lines (measuring lines, wiring, downstream devices) should be taken into consideration. If the fault is not found after checking these points, we recommend sending the device to the supplier.

**Decommissioning!**

Switch off the power supply on all poles if the device is to be decommissioned. Secure the device against unintentional operation! If the device is connected to other devices and / or equipment, the effects must be considered and appropriate precautions taken before switching off.

The following special regulations must be observed:

- The cables must be correctly inserted through the cable ducts by a professional.
- Cable ducts not required must be furnished with sealing bolts by a professional.
The ATEX certification only maintains its validity if the installation is carried out correctly by a professional under the safeguarding of the protection class specified on the marking.
- Cleaning of the housing is only permitted with moist cleaning materials to avoid static charging.
- Cleaning is necessary to prevent increased dust generation on the device.
- Operation under voltage, in zone 22 and 2, only in closed state.
- Before closing, ensure that the device housing is free of dust.

3 Technical Data

Electric supply	
Voltage	19...36 V DC or 100...240 V AC
Power consumption	Max. 2 W

Sensor system				
Measuring range (mbar)	± 1.25, ± 2.5, ± 5, ± 10, ± 25, ± 50, ± 100, ± 350, ± 1000 in accordance with the information on the name plate			
Max. differential pressure	Measuring range	± 1.25 mbar	< 1 bar	
		± 2.5 mbar	< 0.35 bar	
		± 5 mbar		
		± 10 mbar	< 0.5 bar	
		± 25 mbar		
		± 50 mbar	< 1 bar	
		± 100 mbar		
		± 350 mbar	< 5 bar	
± 1000 mbar				
Medium	Air and dry, non-aggressive gases			
Measuring system	Thermal (Bypass Technology)	Piezoresistive	Piezoresistive	Piezoresistive
Measuring ranges (mbar)	± 1.25	± 2.5...± 10	± 25...± 100	± 350...± 1000
Basic accuracy	-	± 1.5 % FSO T = 25 °C	± 1.0 % FSO T = 25 °C	± 0.5 % FSO T = 25 °C
Total error	± 3 % FSO T = -20...85°C	± 2 % FSO T = 0...60°C	± 1.5 % FSO T = 0...60°C	± 1.0 % FSO T = 0...60°C
Pressure connection	Push-in bulkhead fittings for 6 mm hose – outer diameter (4 mm with reduction, <i>see chapter 11 Accessories</i>)			

Input / Output		
Analogue output:	0...10 V	0(4)...20 mA
Max. permissible load	RL ≥ 1 kΩ	RA ≤ 500 Ω
Relay output	1 changeover contact 250 VAC, 5 A as limit value relay	
Service interface	USB / TTL adapter HE 5851 required (<i>see chapter 11 Accessories</i>)	

FSO = Full Scale Output

Housing	
Type	Dust-tight polycarbonate housing
Dimensions	113 × 80 × 60 (W × H × D) 113 × 110 × 60 (W × H × D) incl. connection coupling
Protection type	IP 65
Mounting	Wall-mounted, vertical mounting position
Cable gland	1 × M20 × 1,5 N (for cable diameters 6-12 mm) with multiple sealing insert for 2 x cables Ø 6 mm

Identification	
Device identification/explosion protection	<i>See chapter 2.4 Device Identification</i>

Climatic environmental conditions	
Storage	-20°...+60° C
Transport	-20°...+85° C
Operation	-20°...+55° C In EX zone: -20 °C...+40 °C
Relative air humidity	75% rel. humidity, no condensation

Air and creepage distances	
Pollution degree	2
Overtoltage category	II
Material group	IIIa
Rated voltage	< 150 V AC, ≤ 250 V AC
Test voltage (basic insulation):	1250 V AC, 1 min
Test voltage (added insulation):	3000 V AC, 1 min

Power connection	
Connection type	Push-in-spring connection
Wire size	0.2 mm ² ...1.5 mm ²
Flexible wire size	0.2 mm ² ...1.5 mm ²
AWG wire size / kcmil	24...16
Flexible wire size with ferrule without plastic sleeve	0.2 mm ² ...1.5 mm ²
Flexible wire size with ferrule with plastic sleeve	0.2 mm ² ...0.75 mm ²

Extras	
Special characteristics	Free from silicone ¹

¹ Silicone is not used in the production process.

Mean Time Between Failures				
MTBF [a ²]	Power supply 19...36 V DC without limit signal	Power supply 100...240 V AC without limit signal	Power supply 19...36 V DC with limit signal	Power supply 100...240 V AC with limit signal
Without display	545	167	-	-
With display	486	161	431	119

Mean Time to Dangerous Failure				
MTTF _d [a]	Power supply 19...36 V DC without limit signal	Power supply 100...240 V AC without limit signal	Power supply 19...36 V DC with limit signal	Power supply 100...240 V AC with limit signal
Without display	1090	334	-	-
With display	972	322	862	238

² anno

4 Mounting

The ambient temperature at the installation point must not exceed the permissible temperature for nominal use specified in the technical data. The special regulations for use in EX ATEX Zones must be observed (see chapter 2.3 Safety in the individual operating phases)



Note!

A **drill template** can be found on the internet on: www.hesch.de.
When you print it, please ensure to print out Document 1:1.
Ensure the size accuracy of the print-out before drilling.

4.1 Dimensions

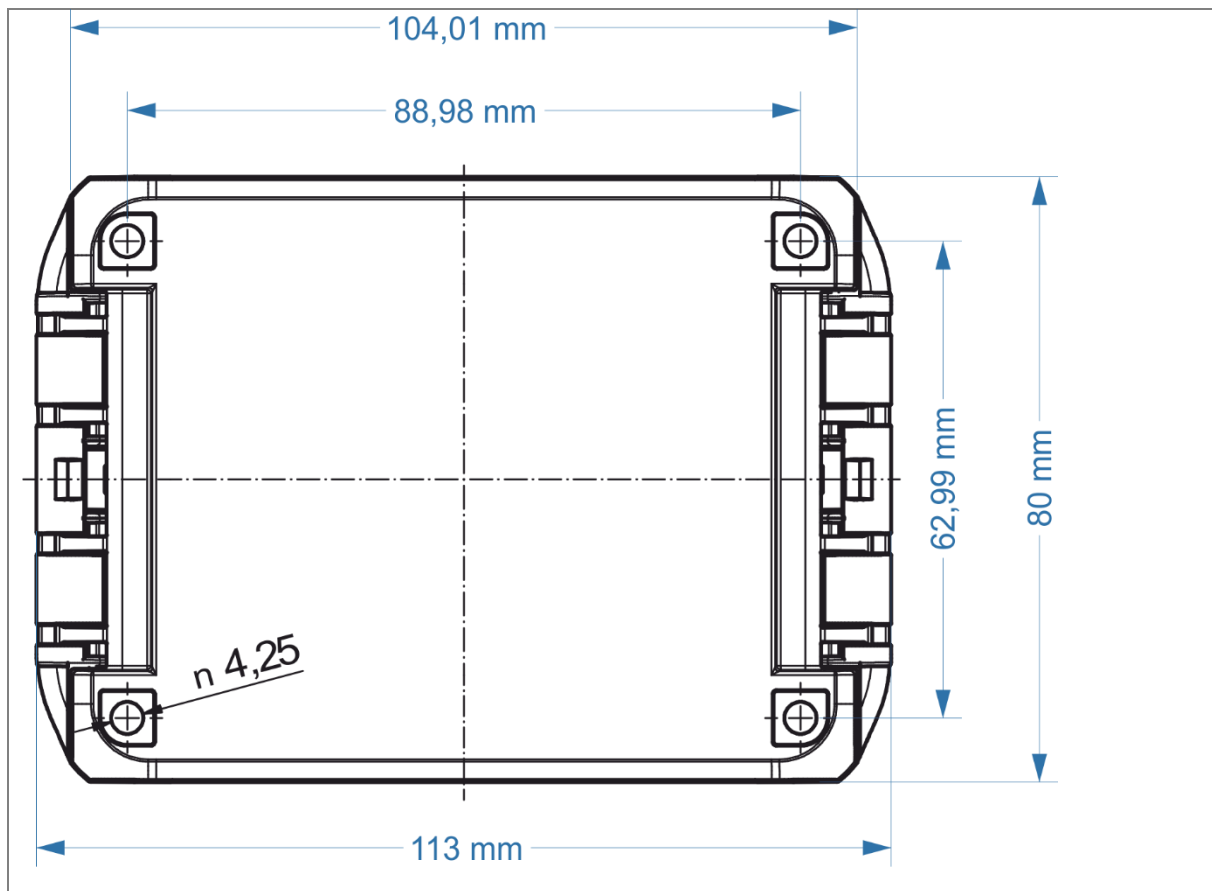

Figure 1. *Back of housing*

The dimensions including the connection couplings are 113 × 110 × 60 mm.

Scope of Delivery

- HE 5411 differential pressure transducer
- Operating Instructions



Note!

Upon receipt, check the delivery for completeness and visible defects. In the event of a complaint, contact your responsible HESCH representative immediately.

4.2 Opening the device

The opening and closing is without screws by means of hinge technology. A flat-tip screwdriver is needed to open the device. Apply the screwdriver to the position intended for this on the housing lid, in order to lift up the hinge. Open the case cover to the left up to an angle of 105°.

Optionally, the housing lid can be closed with 4 additional screws (see *chapter 11 Accessories*) in order to protect it from unauthorised access.

The screwless hinge closure is recommended for rapid service access.

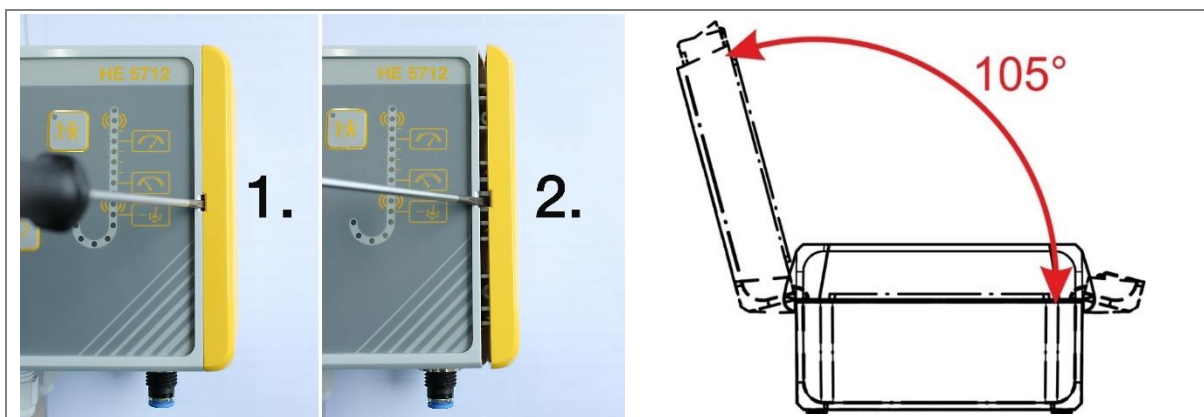

Figure 2. Open the housing lid to the left. (The illustration does not show the HE 5411, but one with a structurally identical housing. The opening principle is identical.)

4.3 Mounting the device

4 screws are required to fasten the device to the wall. (Not included in the scope of delivery!)

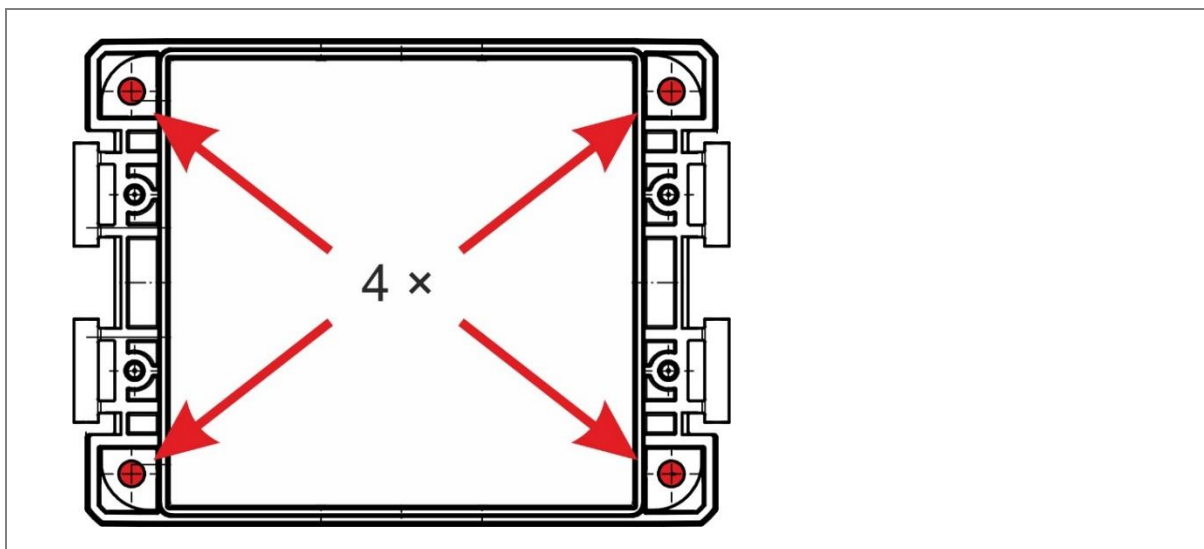

Figure 3. Base of the housing

Alternative: Fastening to the wall with wall brackets. (see *chapter 11 Accessories*)

5 Device Description

The differential pressure transducer records the differential, over- and negative pressure between two pressure inputs, and converts the measurement value into a linear or square-rooted output signal of 0(4)...20 mA or 0...10 V.

The 4-digit 7-segment display also allows the display of negative pressures.

5.1 Summary of device versions

5.1.1 HE 5411 Lite (**without** limit signal)



Figure 4. *Front view HE 5411 Lite*

5.1.2 HE 5411 Basic (**without** limit signal)



Figure 5. *Front view HE 5411 Basic*

5.1.3 HE 5411 Premium (**with** limit signal)



Figure 6. *Front view HE 5411 Premium*

6 Electrical Commissioning

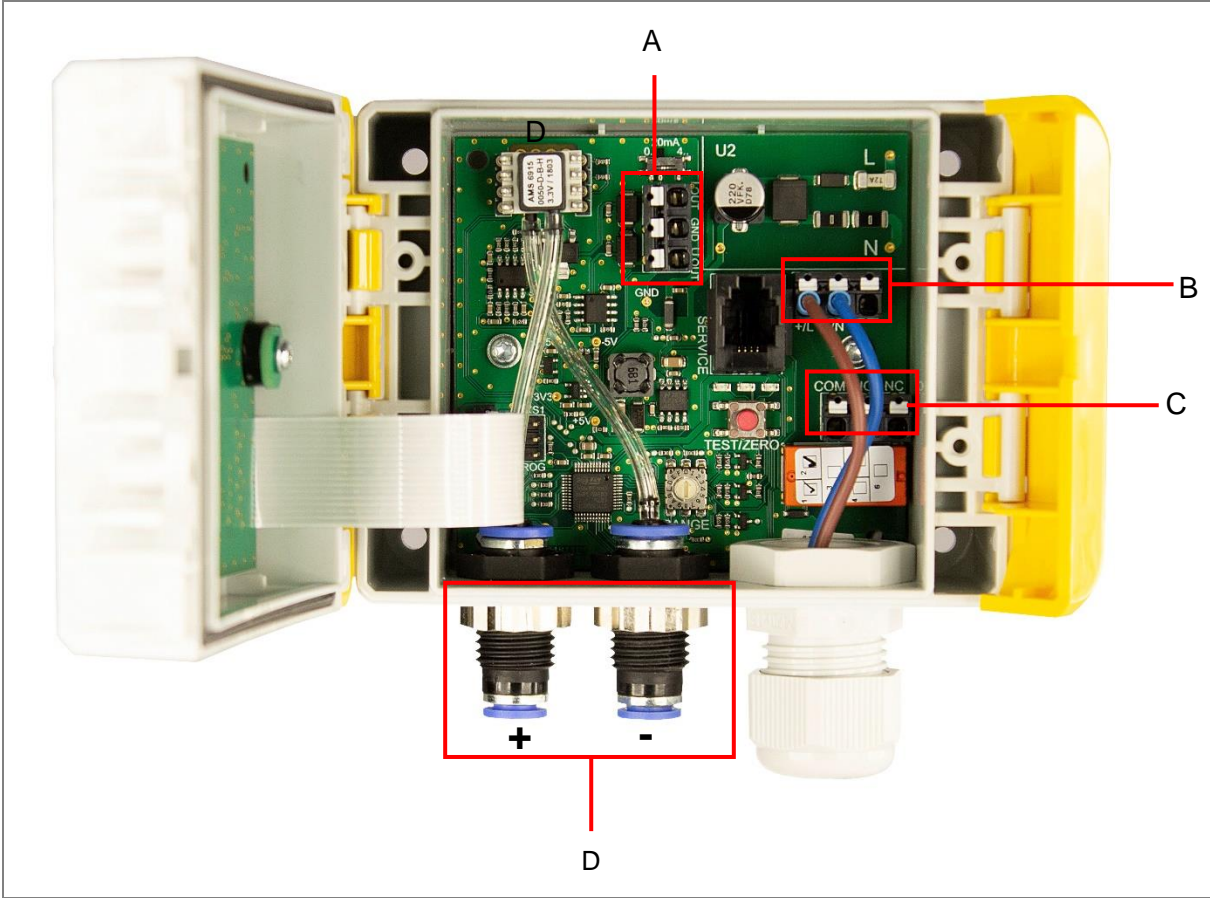
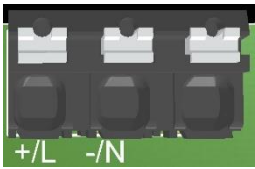
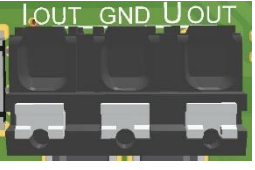



Figure 7. HE 5411 differential pressure transducer, 24 V DC (interior view)



Note! Before commissioning, please note the information on the nameplate!

6.1 Electrical connections

Connections	Meaning			
	B	Supply voltage (Figure 7 shows 24 V DC device)		
		Connection	DC Signal Version	AC Signal Version
		+/L	19...36 V DC	100...240 V AC
		-/N	GND	N
	A	Analogue output I OUT Current output 0(4)...20 mA GND GND U OUT Voltage output 0...10 V		
	C	Relay output (limit value) 		
	D	Pressure inputs The pressure inputs are to be connected with the shortest possible hoses. These hoses must be: p+ (raw gas) larger than p- (clean gas)		



Danger of Electrocutation!

Electrical installation must only be carried out when the power is disconnected.



Warning of material damage caused by electrostatic charge!

Observe the safety measures according to DIN EN 61340-51/-3 to avoid electrostatic discharge!



Note!

Work on the electronics may only be carried out by qualified personnel.

Take the value of the correct supply voltage from the nameplate!

There are device versions with 100-240 V AC and device versions with 19-36 V DC supply voltage.

Before switching on the device, observe the following points:

- The cables must have been connected by a professional.
- The power supply must correspond to the voltage indicated on the nameplate.
- The device may only be operated in closed condition.
- The temperature restrictions specified for the use of the device must be observed before and during operation.

6.2 Assembly of measuring hose onto pressure connection

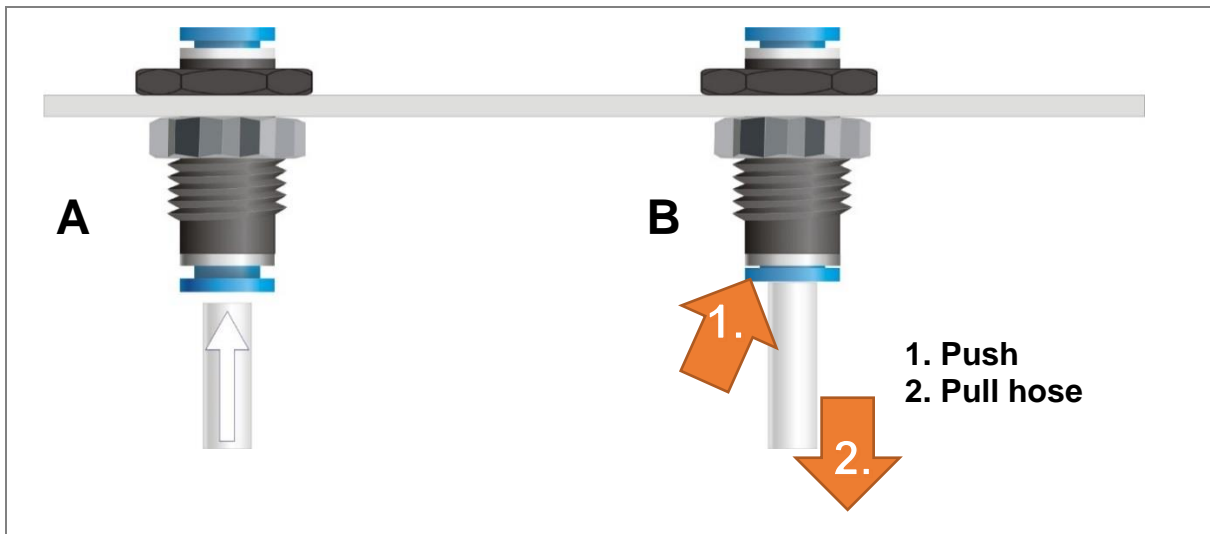

Figure 8. *Assembly of hose onto push-in bulkhead fitting*

A Hose connection

Insert hose with 6 mm outer diameter into the connection.

B Hose disconnection

1. Press the blue retaining ring to open the lock.
2. Pull the hose out of the connection.

7 Display and Operating Elements

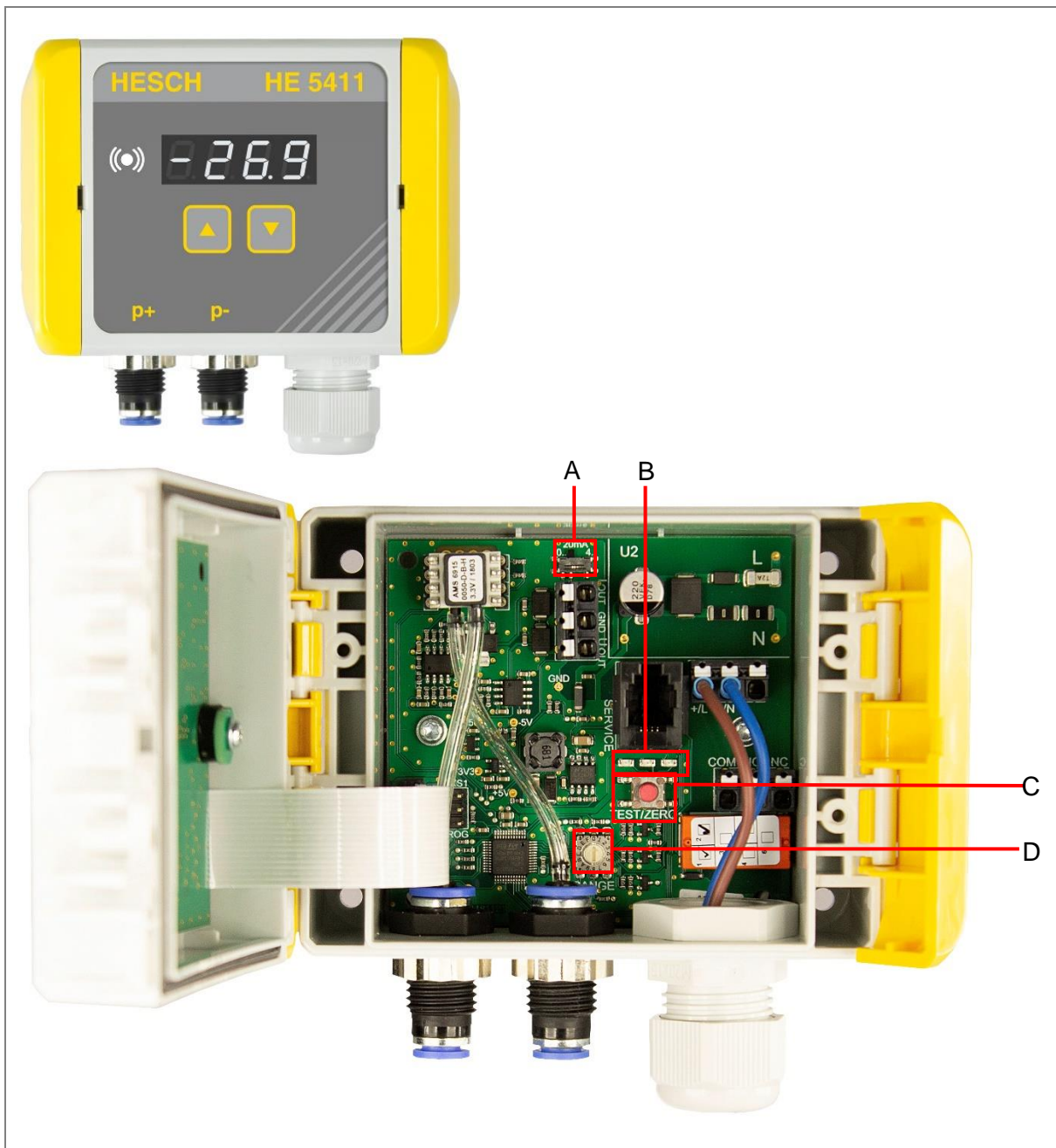



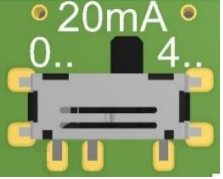

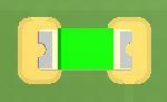

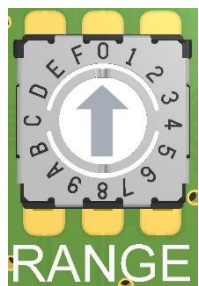

Figure 9. HE 5411 Premium Display and Operating Elements (outside and inside)

- A 0(4)...20 mA switch
- B LEDs
- C Test button
- D Rotary coding switch

Symbols/Displays	Meaning	
		UP key: increase the displayed value
		DOWN key: decrease the displayed value
		Three-coloured Limit LED with colour changes to show status.
		Display: <ul style="list-style-type: none"> • Normal operation: current differential pressure • Parameter setting mode: Limit value set • Switch between the two with UP / DOWN keys
	A	The slide switch lets you switch the analogue output between <ul style="list-style-type: none"> • 0...20 mA (left) • 4...20 mA (right)
	B	LEDs (from left to right)
		Flashes continuously (o—o—o—o) when the differential pressure is in the range of $\pm 10\%$ from the measuring range end value to the zero point. Flashes continuously (o—o—o—o—o—o), when an offset has been programmed.
		Lights up as soon as the supply voltage is present
		Lights up when the differential pressure measured is \geq the limit value set Flashes when the device is in test mode
	C	TEST button for zeroing / Test mode
	D	Rotary coding switch, 16 levels (0...F) to set the measuring range.

7.1 Limit LED

The limit LED serves as a status display for rising or falling pressure. This function is of particular advantage in the case of pressures around the set limit value, since the hysteresis can be read by means of the LED colours.



Note!

The limit relay hysteresis can only be set with the “EasyTool Controls” PC software, Version 4.0 or later. The factory setting of the hysteresis is 1 %.

7.1.1 “Limit threshold” mode

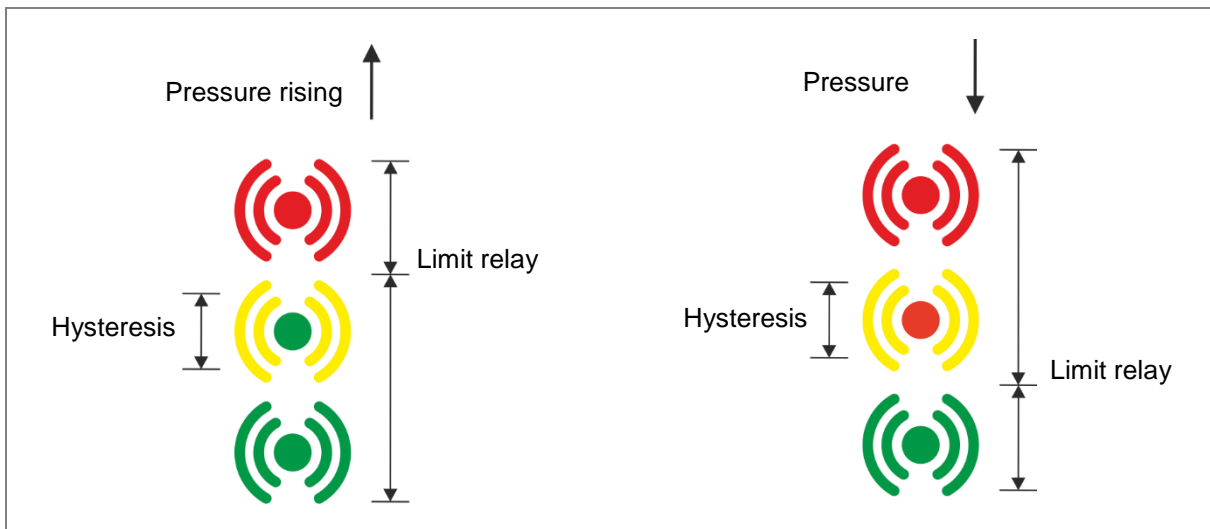

Figure 10. *Limit LED status display in “Limit threshold” mode*

LED	Meaning
	If the status display shows a single-colour green light, this means that the measured pressure is below the limit value and outside of the set hysteresis range.
	If the status display shows a green/yellow light, this means that the measured pressure is below the limit value and inside the set hysteresis range.
	If the status display shows a single-colour red light, this means that the measured pressure is over the limit value and outside of the set hysteresis range.
	If the status display shows a red/yellow light, this means that the measured pressure is over the limit value and inside the set hysteresis range.

7.1.2 "Limit window" mode

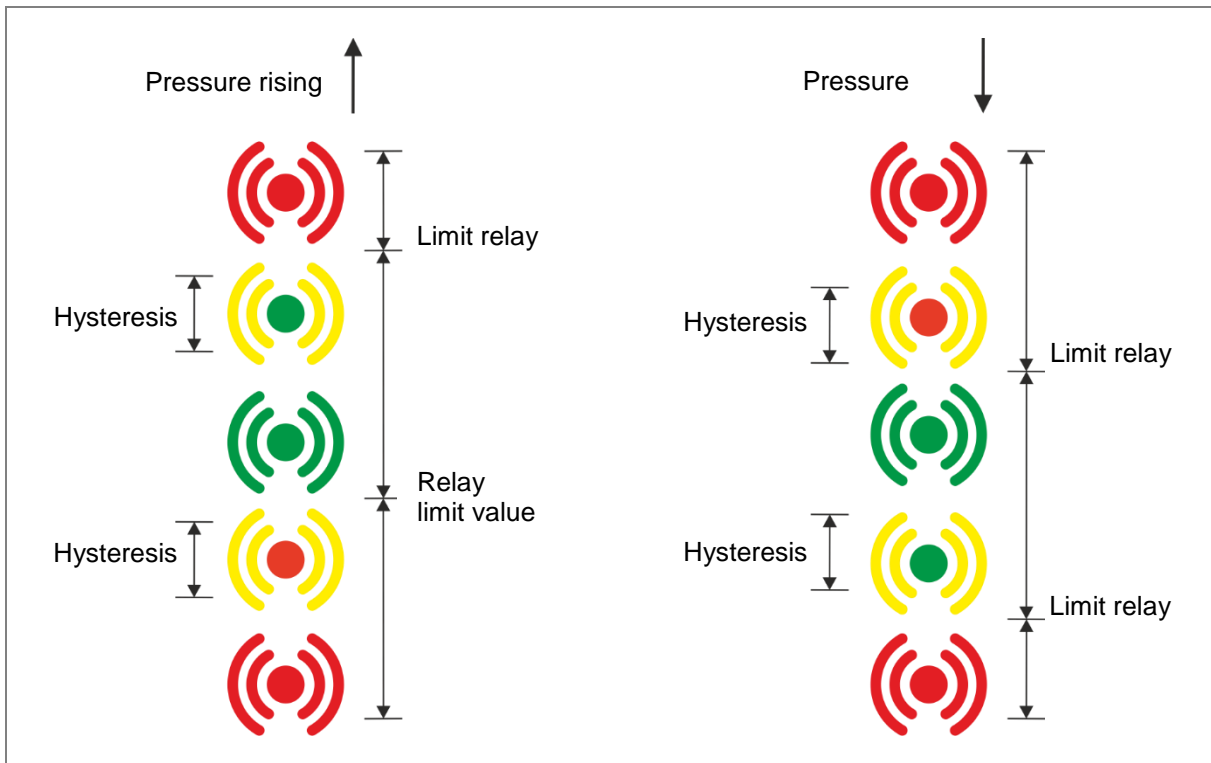





Figure 11. *Limit LED status display in "Limit window" mode*

LED	Meaning
	If the status display shows a single-colour green light, this means that the measured pressure is between the limit values and outside of the set hysteresis range.
	If the status display shows a green/yellow light, this means that the measured pressure is between the limit values and inside the set hysteresis range.
	If the status display shows a single-colour red light, this means that the measured pressure is over or under the limit values and outside of the set hysteresis range.
	If the status display shows a red/yellow light, this means that the measured pressure is over or under the limit values and inside of the set hysteresis range.

8 Operation

8.1 Offset for Zeroing



Note!

The device has been set to the correct value in the factory and does not need to be modified.



Explosion hazard!

This function must only be used outside of EX Zones, since the housing must be opened under voltage. Before opening the housing, make sure that no explosive environmental conditions, such as dust, exist.

Should a zeroing need to be carried out, a warm-up time of 30 minutes must be observed.

2 x short



1. Double clicking on the button will accept the current pressure at the pressure connections as 0 mbar (AUTO ZERO). The measured pressure must be in the range of $\pm 10\%$ from the sensor measuring range to the zero point in order to achieve a successful zeroing.

1 x long



2. A long press on the button resets the offset with respect to the zeroing to 0 mbar.

8.2 Offset for zeroing with device keypad (HE 5411 Premium)

Should a zeroing need to be carried out, a warm-up time of 30 minutes must be observed.



1. Press buttons UP and DOWN. The current pressure at the pressure connections will be accepted as the offset. The measured pressure must be in the range of $\pm 10\%$ from the measuring range end value to the zero point in order to achieve a successful zeroing.



2. "Zero" and the offset to be accepted flash alternately on the display.



3. The UP button confirms acceptance.



4. "Set" will be shown briefly. Following this, the device enters into operation mode.



The offset will be set to 0 mbar.

or



8.3 Limit value parameter setting with device keypad (HE 5411 Premium)



1. The 7-segment display shows the current actual value.

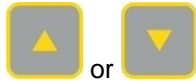

2. Hold the UP button pressed down for 3 seconds to edit the upper limit value.
Hold the DOWN button pressed down for 3 seconds to edit the lower limit value.



3. PASS appears briefly on the display.

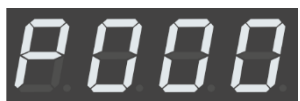

4. When the UP or DOWN button is released, you will be asked to enter the password.

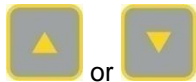

5. Enter the password using the UP or DOWN buttons.



6. Hold both buttons down to confirm the password.
If you have entered the password correctly, continue with step 7.



If you have entered the wrong password, the display goes back to the actual value. Repeat steps 1. to 6.



The point at the bottom right of the display is flashing.



7. Press the UP or DOWN button to set the upper and lower limit value.



8. Hold both buttons down simultaneously to save the limit value set.

The limit value set flashes for 3 seconds.



9. If the **lower** limit value is set to the minimum value, the display shows OFF and the limit value is deactivated.
10. If the **upper** limit value is set to the maximum value, the display shows OFF and the limit value is deactivated.

8.4 Analogue Output Setting

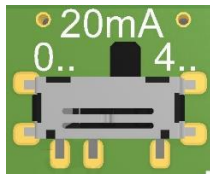

- The analogue output can be selected between 0...20 mA or 4...20 mA with the slide switch.
 - 0...20 mA (left)
 - 4...20 mA (right)

8.5 Setting the measuring range

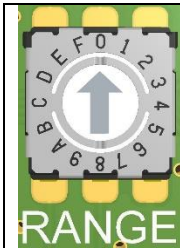

The measuring range is set with the rotary coding switch. The different spreads depend on the full measuring range of the sensor used.

The following table shows the measuring ranges which can be configured.

Rotary coding switch position	Measurement range	Display
0	Set with the PC tool	
1	100 % bidirectional	pressure
2	80 % bidirectional	pressure
3	50 % bidirectional	pressure
4	100 % unidirectional	pressure
5	80 % unidirectional	pressure
6	50 % unidirectional	pressure
7	100 % bidirectional, square rooted	%
8	80 % bidirectional, square rooted	%
9	50 % bidirectional, square rooted	%
A	100 % unidirectional, square rooted	%
B	80 % unidirectional, square rooted	%
C	50 % unidirectional, square rooted	%
D	Free (100 % bidirectional)	pressure
E	Free (100 % bidirectional)	pressure
F	Free (100 % bidirectional)	pressure

8.6 Test Mode

The transmission of the analogue signal can be tested in Test Mode



Explosion hazard!

This function must only be used outside of EX Zones, since the housing must be opened under voltage. Before opening the housing, make sure that no explosive environmental conditions, such as dust, exist.

1 x short



1. Pressing the “TEST” button once switches the analogue outputs to 50 % (10/12 mA or 5 V).



2. The Mode ends by itself after 300 s, and the analogue outputs display the current measured pressure again. The countdown from 300 s to nought and the word “TEST” are shown alternately on the 7-segment display.

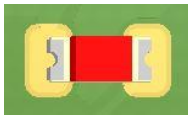

The red LED flashes!



Pressing the “TEST” button again ends the Mode immediately, before the countdown from 300 s is over.

9 Parameter setting with Service PC

The “EasyTool Controls” software from Version 4.x is required to set the parameters with a service PC.

The USB/TTL adapter required for that purpose is available from HESCH (see *chapter 11 Accessories*). The program allows a configuration to be saved, or a saved configuration to be established again.



Note!

The limit relay hysteresis can only be set with the “EasyTool Controls” PC software, from version 4.x. The factory setting of the hysteresis is 1 %.

A USB/TTL adapter is required for this purpose.

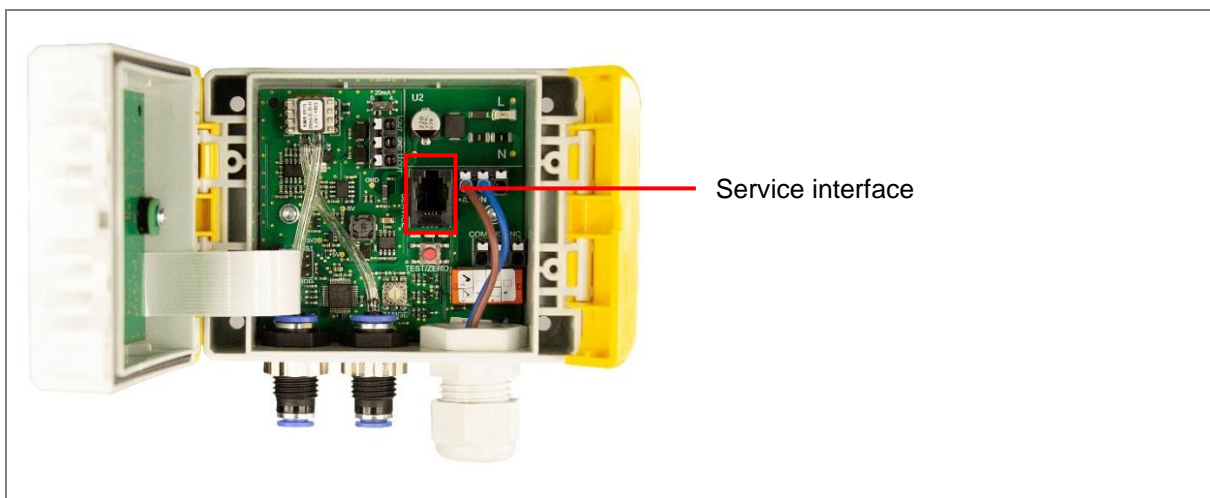

Figure 12. HE 5411 Service interface in the housing

1. Connect the PC to the operating unit via USB cable.
2. Start “EasyTool Controls”.
3. Choose the correct interface on the “Settings” menu.
4. Documents or data can now be transferred.

9.1 Parameter Table

Sensor Min. = Base measuring range start
 Sensor Max. = Base measuring range end



Note!

The base measuring range is to be taken from the nameplate!



Note!

Please note that, when setting the measuring range start and end, the difference between the two must not be less than 25% of the base measuring range!

Parameter	Adjustment range	Factory Setting	Unit
Input signal			
Damping (time constant T) <ul style="list-style-type: none"> The damping is implemented as a first-order low-pass. It affects the measured value and stabilizes a fluctuating input signal (see <i>Figure 13</i>) Approx. 99 % of the end value are reached, after the fivefold time, set via the parameter 'Damping' (see <i>Figure 14</i>) The higher the damping value, the slower does the output signal respond. 	0.00...60.00	2	s
Offset <ul style="list-style-type: none"> This parameter can also be set on the device itself. (see <i>chapter 8.1 and chapter 8.2</i>) 	-10%...+10% from base measuring range end	0.00	
Measuring range start <ul style="list-style-type: none"> The measuring range start indicates the pressure at which an output signal of 0% is displayed. 	Sensor Min...Sensor Max	Base measuring range start	mbar
Measuring range end <ul style="list-style-type: none"> The measuring range end indicates the pressure at which an output signal of 100% is displayed. 	Sensor Min...Sensor Max	Base measuring range end	

Parameter	Adjustment range	Factory Setting	Unit
Characteristic line <ul style="list-style-type: none"> If the parameter “Characteristic line” is on the table, the characteristic line can be defined with the parameters “Base Output Signal 1”, “Base Output Signal 1” and “Base Output Signal 30”, “Base Output Signal 30”. 	linear, square-rooted, table		
Base Output Signal 1	0...100		%
Base Input Signal 1	Sensor Min...Sensor Max		mbar
...			
Base Output Signal 30	0...100		%
Base Input Signal 30	Sensor Min...Sensor Max		mbar
Number of bases	2...30		

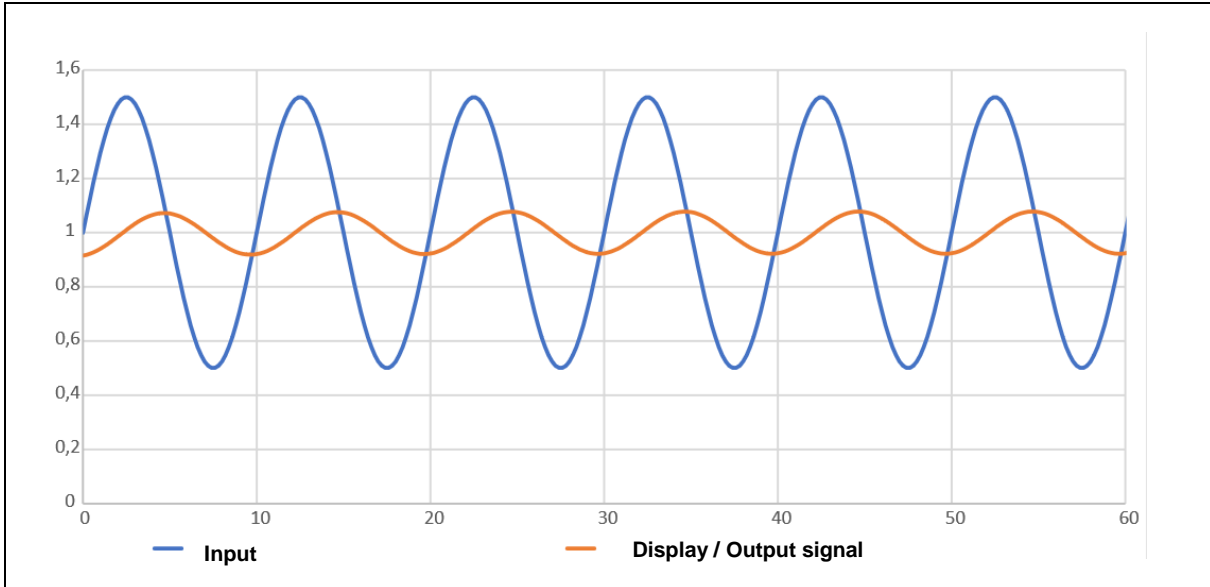

Figure 13. *Example for damping a fluctuating signal*

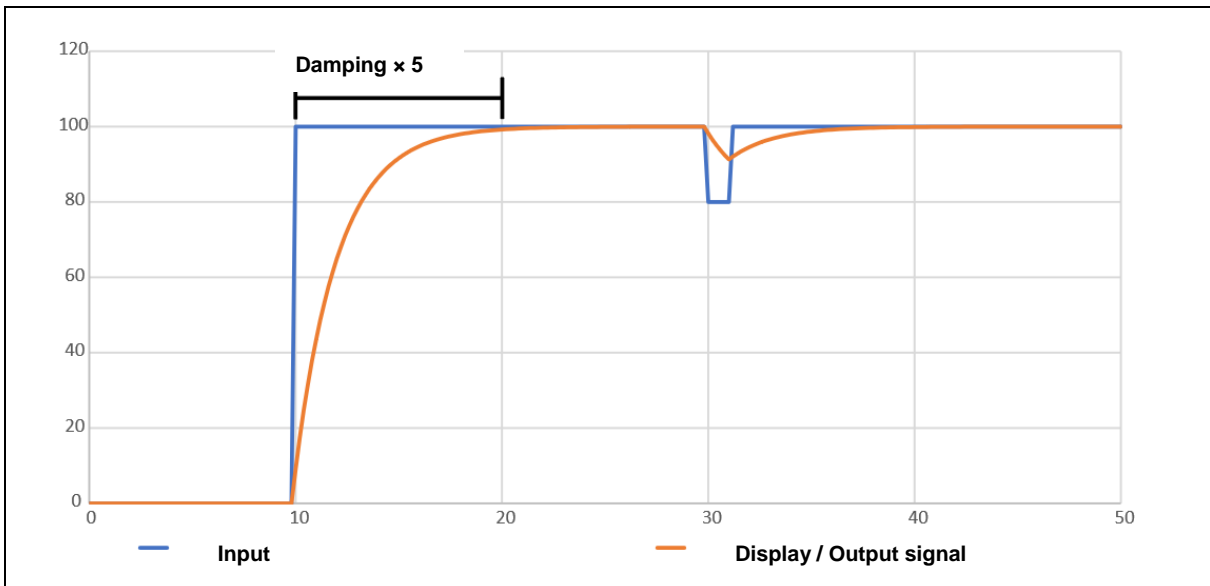

Figure 14. *Example for step response*

Parameter	Adjustment range	Factory Setting	Unit
Display / Output			
Creep flow suppression <ul style="list-style-type: none"> Flattens the output signal after root extraction at small differential pressures (around zero). Functionalities: None (function is deactivated) Step (the parameter 'creep flow threshold' defines the range around zero. Within this range, the displayed value and the output signal are set to zero, see <i>Figure 15</i>. Is mostly used when the volume flow is subsequently added up.) Linear (the parameter 'creep flow threshold' defines the range around zero. Within this range, the square rooted characteristic line is replaced by a linear one => increase around zero is limited, see <i>Figure 16</i>. Mostly used for downstream controls.) 	None, step, linear	Step	
Creep flow threshold <ul style="list-style-type: none"> Min. = Display value start Max. = Display value end 	Min...Max.	10% from Max.	
Unit The unit you wish to be displayed can be set with this parameter.	mbar, Pa, inH2O, psi,		
Display value start	-999.00...9999.00	0.0	
Display value end	-999.00...9999.00	100.0	
Upper limit value <ul style="list-style-type: none"> This parameter can also be set on the device itself. See <i>chapter 7.1</i> 	Sensor Min...Sensor Max, Off	75% of basic measuring range end	mbar, Pa, inH2O, psi
Upper hysteresis limit value <ul style="list-style-type: none"> See <i>chapter 7.1</i> 		1% of basic measuring range end	

Parameter	Adjustment range	Factory Setting	Unit
Lower limit value <ul style="list-style-type: none"> See chapter 7.1 	Off, Sensor Min...Sensor Max	Off / 1% of Base measuring range end <ul style="list-style-type: none"> The lower limit value is deactivated by default for sensors with a unidirectional basic measuring range. 	mbar, Pa, inH2O, psi
Lower hysteresis limit value <ul style="list-style-type: none"> See chapter 7.1 		75% of basic measuring range end	
Pick-up delay	0.0...999.9	0	s
Dropout delay	0.0...999.9	0	s
Fail-Safe Relay <ul style="list-style-type: none"> When the "Fail-Safe Relay" parameter is active, the relay is energised in a non-active state. If the upper or lower limit value is overshoot or underrun, the relay is de-energised (see Figure 17). 	Inactive, Active	Inactive	

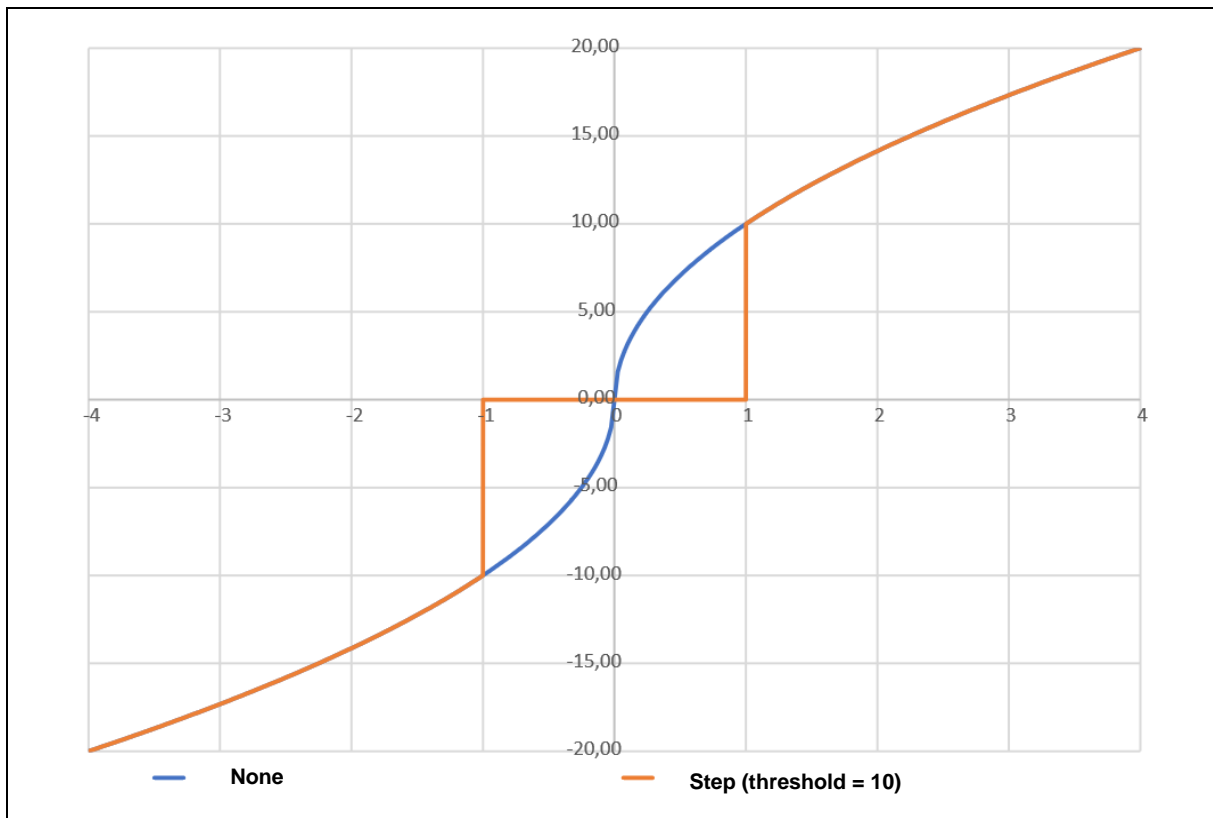

Figure 15. Creep flow suppression 'Step'

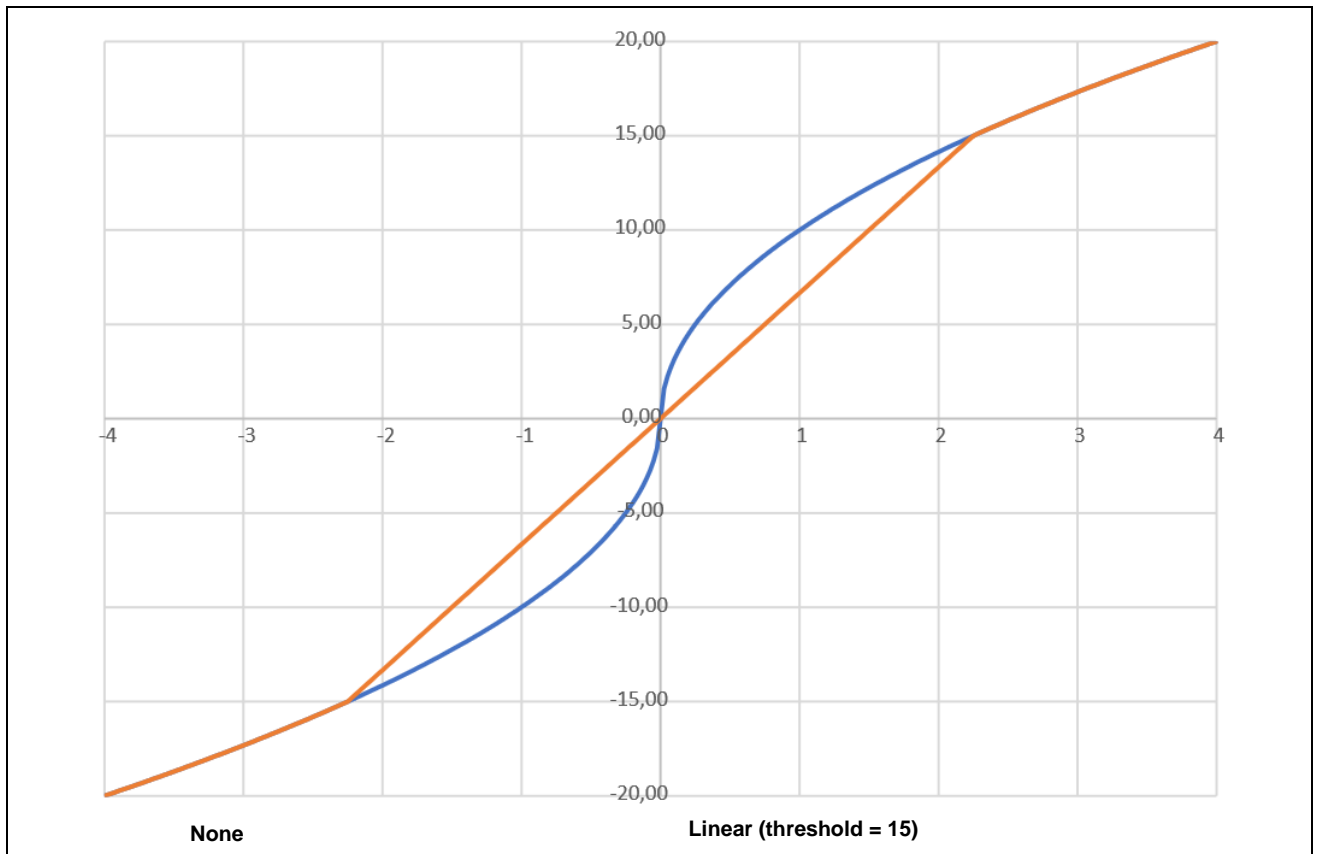

Figure 16. *Creep flow suppression 'Linear'*

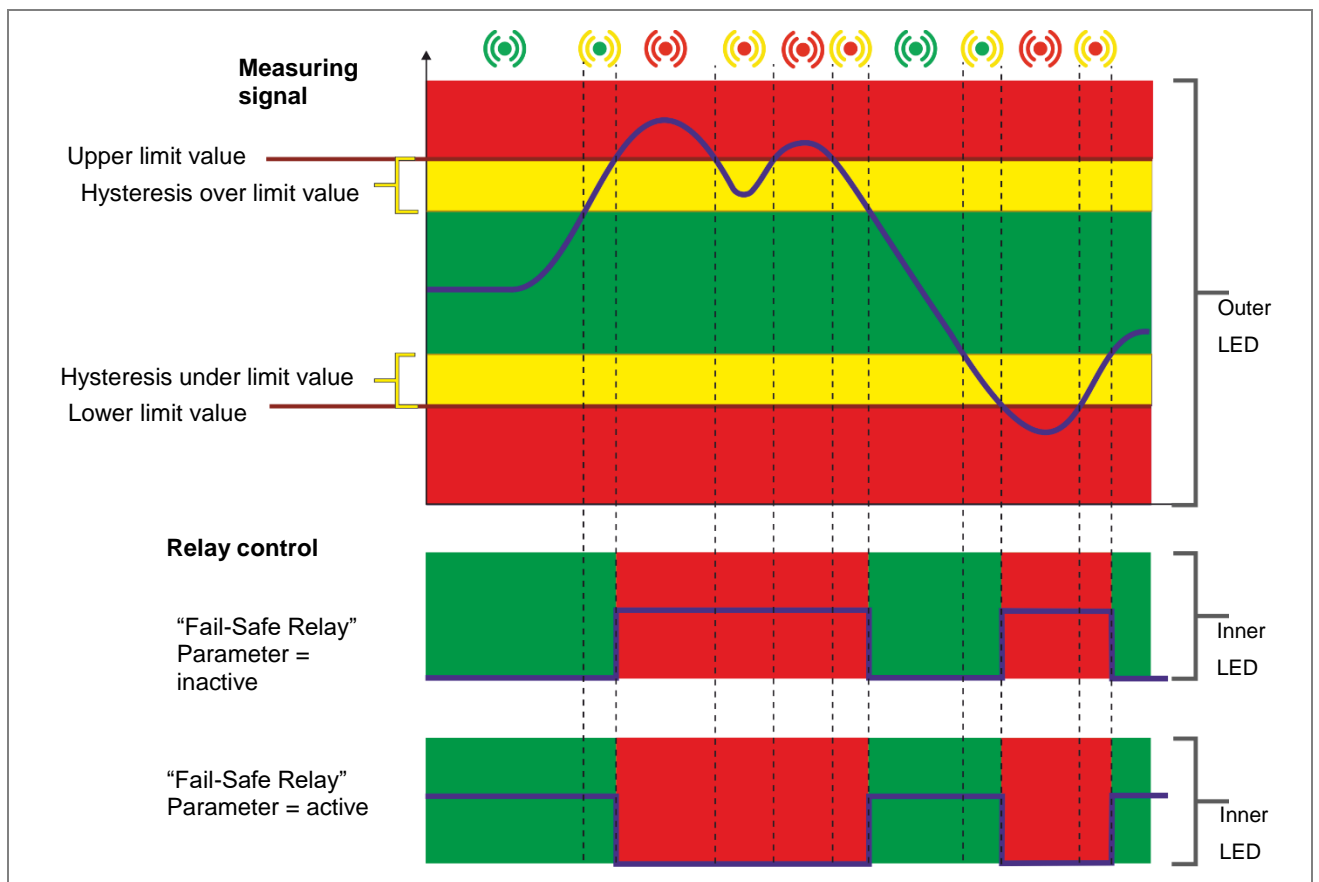



Figure 17. *Configuration of the Limit Value*

Parameter	Adjustment range	Factory Setting	Unit
Test			
<ul style="list-style-type: none"> • See chapter 8.6 			
Test duration	10...300	300	s
Test value current signal	0.00...100.00	50	%
Test value voltage signal	0.00...100.00	50	%







Parameter	Adjustment range	Factory Setting	Unit
Device settings			
Display brightness	50...100	100	%
Password <ul style="list-style-type: none"> • The password must be entered using the UP  and DOWN  buttons before the parameters "Upper limit value" or "Lower limit value" can be set. 	000...999	001	



10 Error Messages

Display	Cause	Troubleshooting
<p>The display shows</p> <p>alternating with the currently measured value.</p>	Measurement range overshoot or pressure connections reversed	<ul style="list-style-type: none"> • Check the measurement range set • Check the pressure connections
<p>The displays shows</p> <p>alternating with the currently measured value.</p>	Measurement range underrun or pressure connections reversed	<ul style="list-style-type: none"> • Check the measurement range set • Check the pressure connections
<p>The display shows</p> <p>alternating with</p>	The calibration data of the sensor is not valid.	<ul style="list-style-type: none"> • The error cannot be solved by the customer. • Please contact HESCH service (see <i>chapter 12 Maintenance and Service</i>)
<p>The display shows</p> <p>alternating with</p>	The sensor is missing or faulty	<ul style="list-style-type: none"> • The error cannot be solved by the customer. • Please contact HESCH service (see <i>chapter 12 Maintenance and Service</i>)
<p>The display shows</p> <p>alternating with the process value or displayed value.</p>	The stored parameters are not valid (e.g. after a firmware update)	<ul style="list-style-type: none"> • Write parameters with the software “EasyTool Controls” • Or set a parameter at the device , e.g. ‘Zeroing’ or ‘Limit’

11 Accessories

HESCH offers a series of optional accessories in connection with the assembly and connection technology of the HE 5411 differential pressure transducer:

Item	Picture	Name	Order number
1		Wall bracket as an alternative means of fastening the HE 5411 housing Colour: Light grey	upon request
2		Housing hinge closure available in various colours: Light grey, graphite grey, bright red, ultramarine blue	upon request
3		Screws (4 pieces) for the optional screwing of the housing. Factory standard 1412, 30x18x10, cross head, left thread	B SHR
4		Δp connection set for HE 54xx and Δp solenoid valve controllers. PVC hose Ø i=4mm Ø o=6mm	# 54109999
5		Universal adaptor set for push-on bulkhead fitting, PU hose Ø i=4mm / Ø o=6mm onto Whitworth pipe thread G 1/4"	# 54210099
6		Reduction 6mm plug nipple x 4 mm hose IQS-Mini	#181452

Item	Picture	Name	Order number
7		Multiple sealing insert 3 x cables Ø 5 mm	upon request
8		USB/TTL adapter Incl. connection cable and "EasyTool Controls" PC software	# 61000011

12 Maintenance and Service

Maintenance, Repair

The device must be cleaned regularly to prevent increased dust generation on the device.

Disposal

Dispatch metals and plastics for recycling. Electrical and electronic components must be collected separately and disposed of accordingly. Dispose of assembled printed circuit boards professionally.

Service

HESCH Industrie-Elektronik GmbH

Boschstraße 8

31535 NEUSTADT

GERMANY

Phone: +49 5032 9535-0

Fax: +49 5032 9535-99

Internet: www.hesch.de

Email: info@hesch.de